

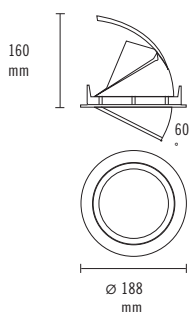

NEXIA PULL OUT

Downlight LED basculante y orientable de inyección de aluminio y reflector anodizado de alta pureza.



03330 -									
Color	CRI / Temp.	Ángulo	Led	Regulación	Clase				
0 Blanco	G 827	1 10°	2 1500 lm / 12 W	D Dali	II				
1 Negro	C 830	2 20°	3 2000 lm / 18 W	B Bluetooth					
2 Gris	N 840	3 40°	4 3000 lm / 25 W						
	H 927	7 70°	5 4000 lm / 35 W						
	E 930		6 5000 lm / 40 W*						
	F 940								

1140 g	175 mm	355°	IP 20	CRI=80/90	2-SDCM	230V	DRIVER <5%	60°	LED

*Sólo se fabrica en temperaturas 830 y 840.

DESCRIPCIÓN

Downlight ajustable y orientable de aluminio con reflector anodizado. Este producto puede ser controlado mediante tecnología Bluetooth. PULL OUT cubre las expectativas más exigentes como solución completa de iluminación. Tres funciones en una sola luminaria: Downlight, bañadores de pared asimétricos Downlight y downlight direccional.

INSTALACIÓN

Sistema de muelles adaptable a diferentes espesores de techo. (Desde 3mm hasta 30mm).

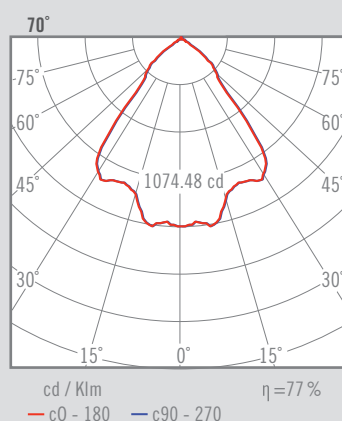
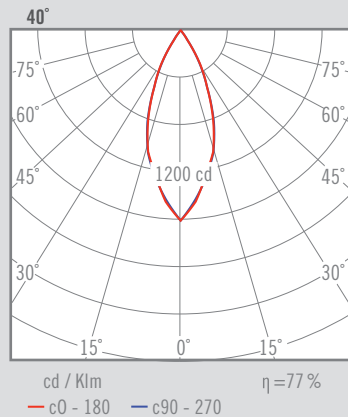
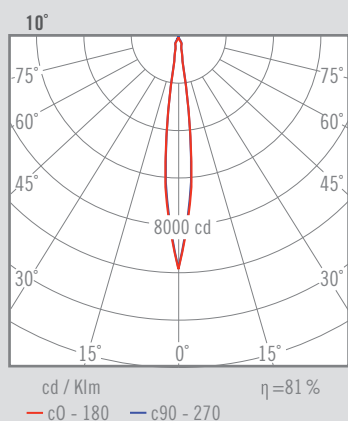
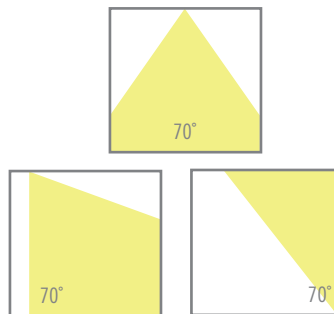
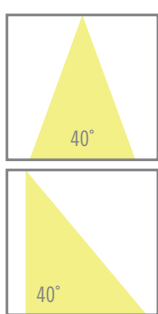
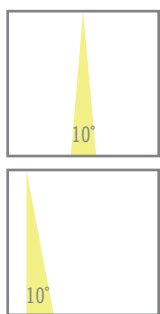

CERTIFICADOS DE CALIDAD :

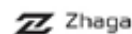



NEXIA PULL OUT

Downlight LED basculante y orientable de inyección de aluminio y reflector anodizado de alta pureza.

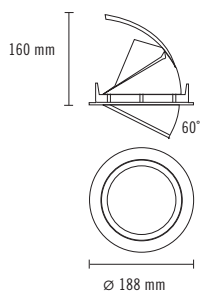

03330 -		ESPECIAL ALIMENTACIÓN / MODA				
Color	CRI / Temp.	Ángulo	Led	Regulación	Clase	
0 Blanco	B Panadería	1 10°	3 2000 lm	D Dali	II	
1 Negro	M Carne	3 40°	4 3000 lm*			
2 Gris	P Pescado	7 70°				
	V Fruta					
	R Moda					

1140 g	175 mm	355°	1	20	IP 230V	DRIVER <5%	60°	LED

*Versión Carne, 2700 lm

DESCRIPCIÓN

Downlight ajustable y orientable de aluminio con reflector anodizado. Este producto puede ser controlado mediante tecnología Bluetooth. PULL OUT cubre las expectativas más exigentes como solución completa de iluminación. Tres funciones en una sola luminaria: Downlight, bañadores de pared asimétricos Downlight y downlight direccional.

INSTALACIÓN

Sistema de muelles adaptable a diferentes espesores de techo. (Desde 3mm hasta 30mm).

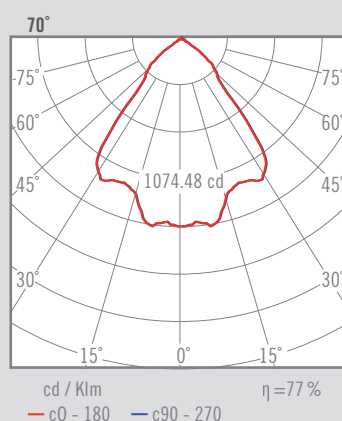
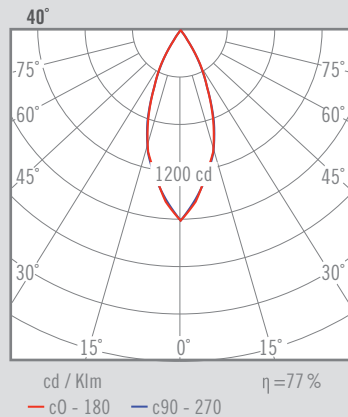
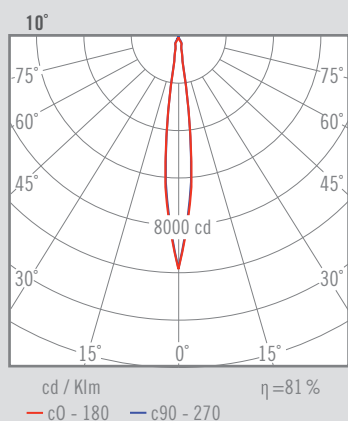
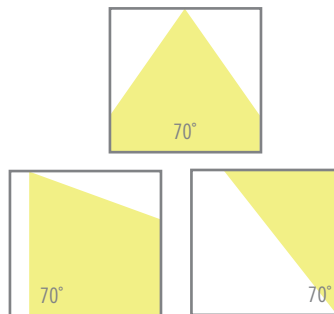
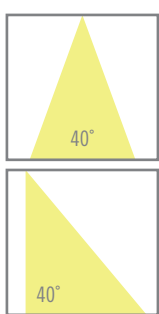
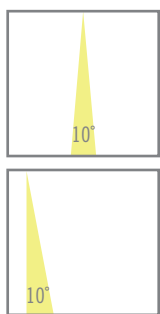

CERTIFICADOS DE CALIDAD :

