

Nexia

How to order the 48V_Track?

purchasing guide

48V_Track

A combination of linear structures. Thanks to its multiple accessories, it allows us to combine technical and decorative lighting in the same space. Its minimalist aesthetics and small dimensions allow us to incorporate linear solutions in any kind of project.



ES

48V_Track es una combinación de estructuras lineales. Gracias a sus múltiples accesorios nos permite combinar iluminación técnica y decorativa en un mismo espacio. Su estética minimalista y de dimensiones reducidas nos permite incorporar la solución lineal en cualquier espacio.

FR

48V_Track est une combinaison de structures linéaires. Grâce à ses multiples accessoires, il nous permet de combiner l'éclairage technique et décoratif dans un même espace. Son esthétique minimaliste et ses petites dimensions nous permettent d'incorporer la solution linéaire dans tout espace.

IT

48V_Track è una combinazione di una struttura lineare. Grazie ai suoi numerosi accessori ci permette unire l'illuminazione tecnica con quella decorativa. Un'estetica minimalista dalle dimensioni ridotte che permette incorporare una soluzione lineare in qualsiasi spazio.

Recessed

Surface

Suspension



ES

Disponible en 3 versiones:
empotrada, de superficie y
suspendida.

FR

Disponible en 3 versions :
encastré, en surface et sus-
pendu.

IT

Disponibile in 3 versioni: a
incasso, a superficie e a sos-
pensione.

Available in 3 versions:
recessed, surface and suspended.

| | |
|-------------------|-------------------|
| Index Protection: | IP20 |
| Voltage: | 48V |
| Driver: | Not included |
| CRI: | 90 |
| Lifetime: | 50.000h |
| Temperature: | 2700K/3000K/4000K |
| Technology: | LED |
| Guarantee: | 5 years |
| Class | III |

A) External power supply option

Surface

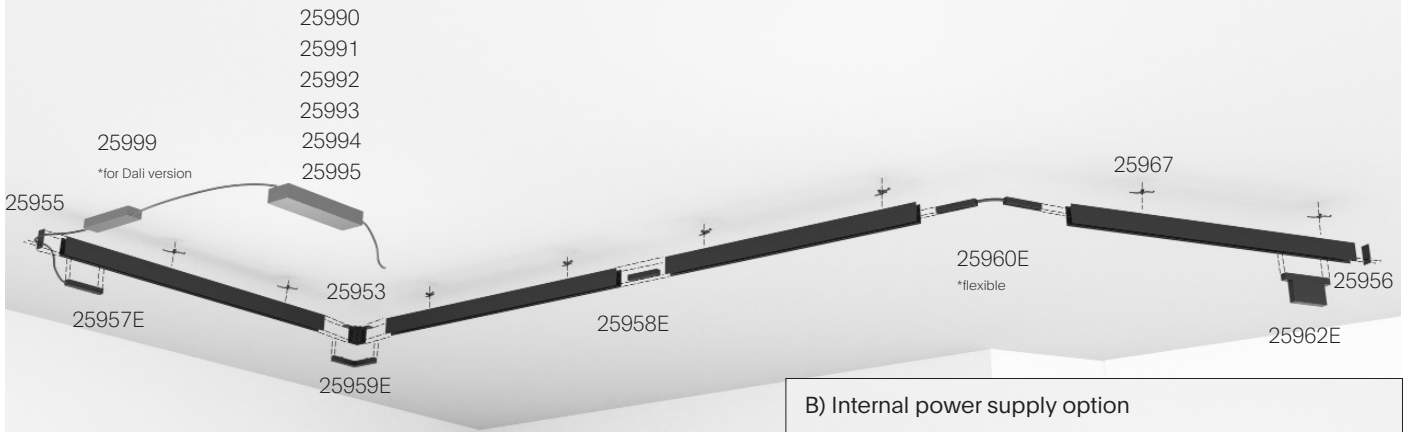

A and B are excluding

Surface mounted track

B) Internal power supply option

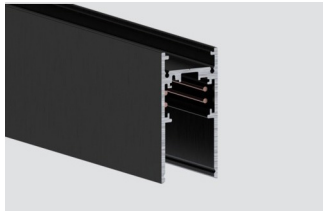
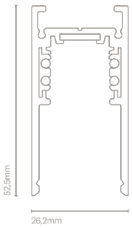
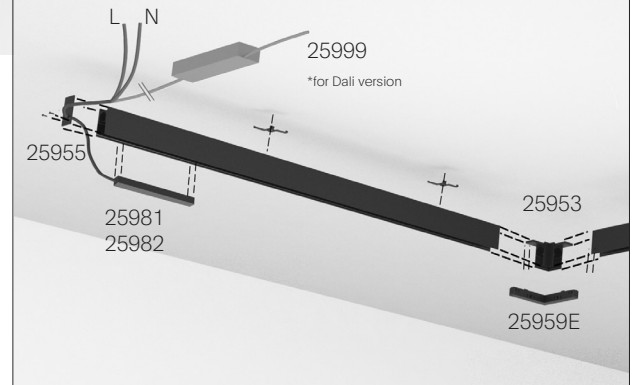

- 25901E-0
- 25902E-0
- 25903 E-0
- 25901E-1
- 25902E-1
- 25903 E-1

| | | | |
|--------------------------------|-----|--------|-------|
| Magnetic track surface mounted | 15A | 100 cm | White |
| Magnetic track surface mounted | 15A | 200 cm | White |
| Magnetic track surface mounted | 15A | 300 cm | White |
| Magnetic track surface mounted | 15A | 100 cm | Black |
| Magnetic track surface mounted | 15A | 200 cm | Black |
| Magnetic track surface mounted | 15A | 300 cm | Black |

Accessories

| | | | | | |
|----------|-------------------------------|-------------------------------------------------------------------------------------|---------|---------------------------------|---------------------------------------------------------------------------------------|
| 25952- | Joint |  | 25959E- | Electrified "L" joint |  |
| 25953- | "L" connector not electrified |  | 25960E- | Electrified flexible joint |  |
| 25955- | End cap with hole |  | 25961 - | Electrical contact cutting tool |  |
| 25956- | End cap without hole |  | 25962E- | Bluetooth (Casambi) adapter |  |
| 25957E - | Power supply |  | 25967- | Ceiling clamp |  |
| 25958E- | Electrified lineal joint |  | | | |

Converters

| | | | | | L | W | H | |
|---------|----------------------------------|------|-----|------|--------|-------|--------|--|
| 25990- | Converter 110 -240V | 75W | 48V | IP00 | 99mm | 97mm | 30mm | |
| 25991- | Converter 110 -240V | 150W | 48V | IP00 | 159mm | 97mm | 30mm | |
| 25992- | Converter 220 -240V | 100W | 48V | IP20 | 350mm | 30mm | 18mm | |
| 25993- | Converter 220 -240V | 250W | 48V | IP20 | 400mm | 40mm | 22mm | |
| 25994- | Converter 110 -277V | 240W | 48V | IP67 | 244mm | 71mm | 38mm | |
| 25995- | Converter 110 -277V | 320W | 48V | IP67 | 252mm | 90mm | 44mm | |
| 25999- | Optocoupler for Dali * | | | | | | | |
| 25962E- | Bluetooth (Casambi-DALI) adapter | | | | | | | |
| 25981- | Converter 230 V | 100W | 48V | IP20 | 300 mm | 16 mm | 19mm | |
| 25982- | Converter 230 V | 250W | 48V | IP20 | 270 mm | 22mm | 43,5mm | |

* Required for Dali signal on track systems.



Flovild Elektro Office, Oslo 2021



A) External power supply option

Suspension

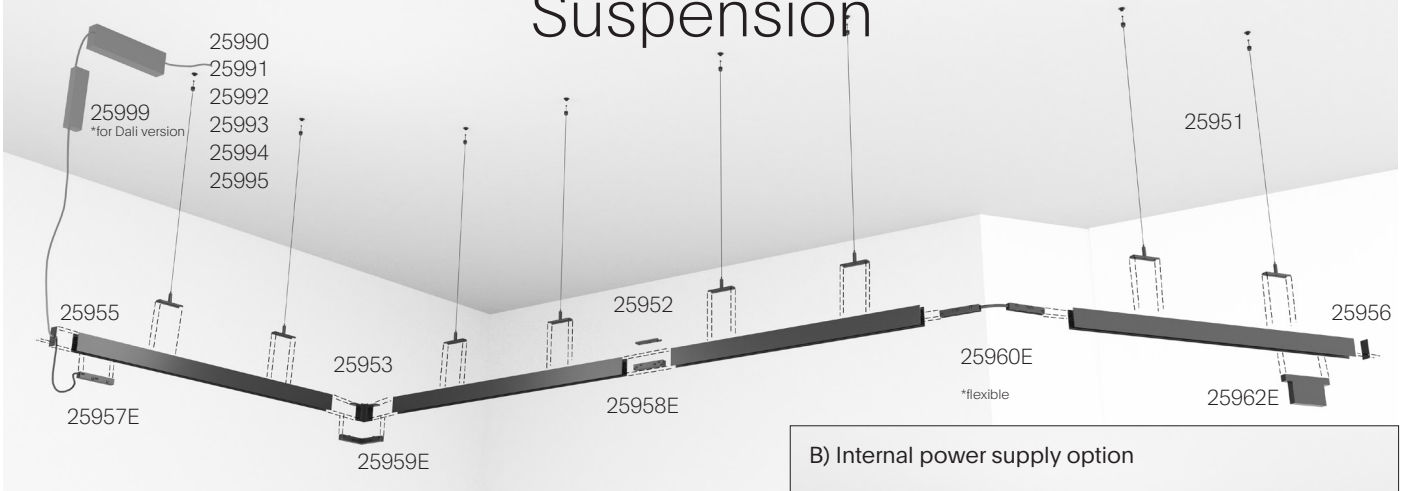

A and B are excluding

Suspension mounted track

B) Internal power supply option

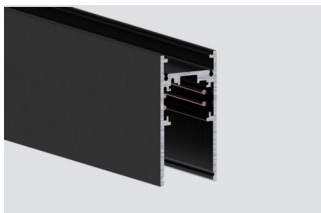
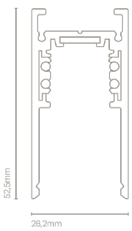
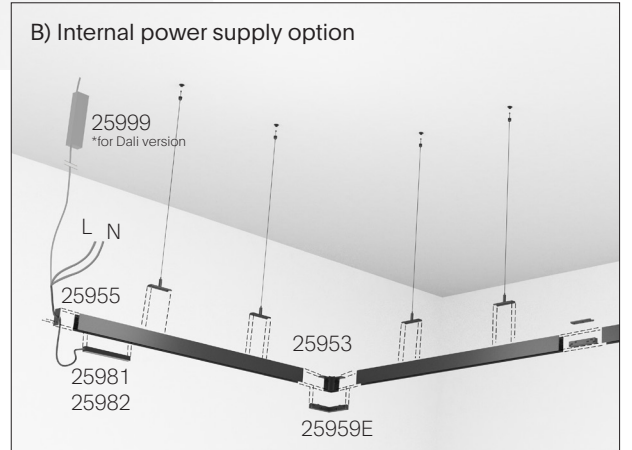

- 25901E-0
- 25902E-0
- 25903 E-0
- 25901E-1
- 25902E-1
- 25903 E-1

| | | | |
|--------------------------------|-----|--------|-------|
| Magnetic track surface mounted | 15A | 100 cm | White |
| Magnetic track surface mounted | 15A | 200 cm | White |
| Magnetic track surface mounted | 15A | 300 cm | White |
| Magnetic track surface mounted | 15A | 100 cm | Black |
| Magnetic track surface mounted | 15A | 200 cm | Black |
| Magnetic track surface mounted | 15A | 300 cm | Black |

Accessories

| | | | | | |
|---------|-------------------------------|-------------------------------------------------------------------------------------|----------|-------------------------------------|---------------------------------------------------------------------------------------|
| 25951- | Suspension Kit |  | 25958E- | Electrified lineal joint |  |
| 25952- | Joint |  | 25959E- | Electrified "L" joint |  |
| 25953- | "L" connector not electrified |  | 25960E- | Electrified flexible joint |  |
| 25955- | End cap with hole |  | 25961- | Electrical contact cutting tool |  |
| 25956- | End cap without hole |  | 25962- | Bluetooth (Casambi) adapter |  |
| 25957E- | Power supply |  | 25969-0S | Telescopic suspension kit 50-100cm | White |
| | | | 25969-1S | Telescopic suspension kit 50-100cm | Black |
| | | | 25969-0 | Telescopic suspension kit 108-209cm | White |
| | | | 25969-1 | Telescopic suspension kit 108-209cm | Black |

Converters

| | | | | | L | W | H |
|---------|----------------------------------|------|-----|------|--------|------|--------|
| 25990- | Converter 110 -240V | 75W | 48V | IP00 | 99mm | 97mm | 30mm |
| 25991- | Converter 110 -240V | 150W | 48V | IP00 | 159mm | 97mm | 30mm |
| 25992- | Converter 220 -240V | 100W | 48V | IP20 | 350mm | 30mm | 18mm |
| 25993- | Converter 220 -240V | 250W | 48V | IP20 | 400mm | 40mm | 22mm |
| 25994- | Converter 110 -277V | 240W | 48V | IP67 | 244mm | 71mm | 38mm |
| 25995- | Converter 110 -277V | 320W | 48V | IP67 | 252mm | 90mm | 44mm |
| 25999- | Optocoupler for Dali * | | | | | | |
| 25962E- | Bluetooth (Casambi-DALI) adapter | | | | | | |
| 25981- | Converter 230 V | 100W | 48V | IP20 | 300 mm | 16mm | 19mm |
| 25982- | Converter 230 V | 250W | 48V | IP20 | 270 mm | 22mm | 43,5mm |

* Required for Dali signal on track systems.



Mas Vell Restaurant, Mas Nou 2020



A) External power supply option

Suspension Up & Down

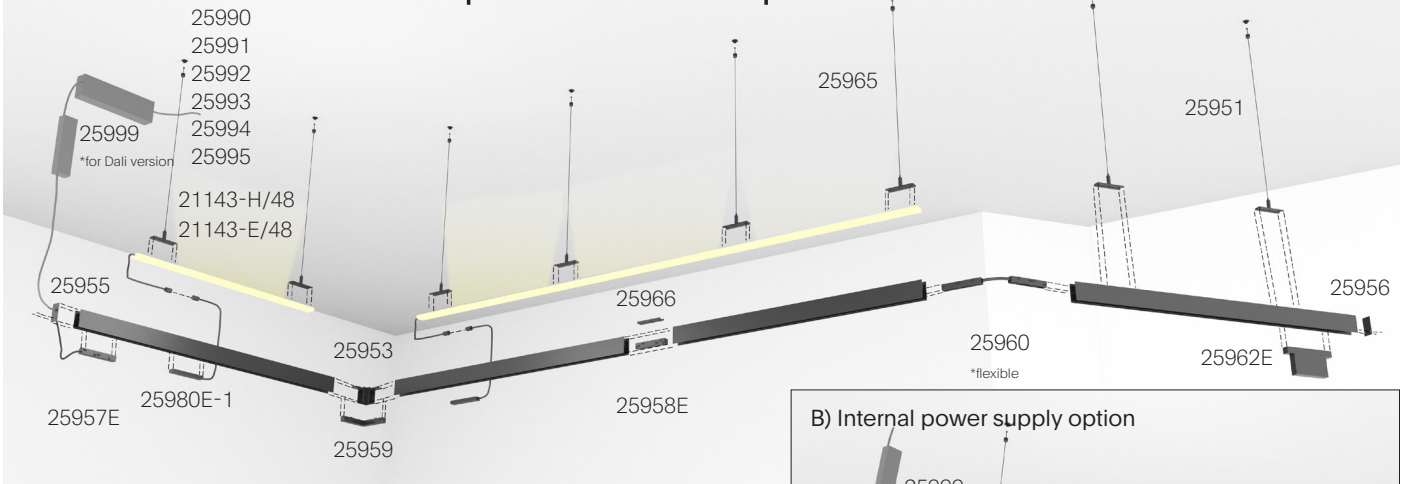

A and B are excluding



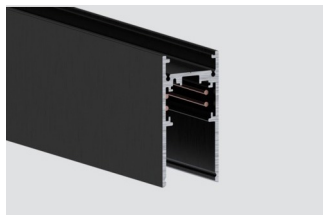
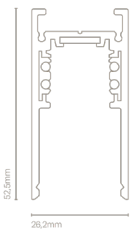
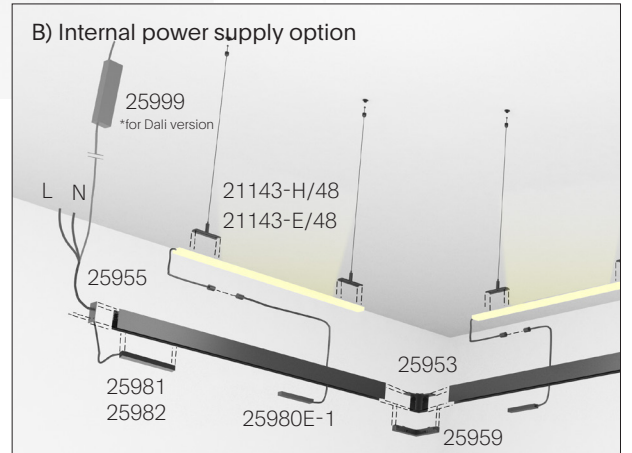



Suspension mounted track



- 25901E-0
- 25902E-0
- 25903 E-0
- 25901E-1
- 25902E-1
- 25903 E-1

| | | | |
|--------------------------------|-----|--------|-------|
| Magnetic track surface mounted | 15A | 100 cm | White |
| Magnetic track surface mounted | 15A | 200 cm | White |
| Magnetic track surface mounted | 15A | 300 cm | White |
| Magnetic track surface mounted | 15A | 100 cm | Black |
| Magnetic track surface mounted | 15A | 200 cm | Black |
| Magnetic track surface mounted | 15A | 300 cm | Black |

Accessories

| | | | | |
|------------|--------------------------------------|----------|---------------------------------|---------------------------------------------------------------------------------------|
| 21143-H/48 | Led strip 48V IP54 2700K 14,4W CRI90 | 25956- | End cap without hole |  |
| 21143-E/48 | Led strip 48V IP54 3000K 14,4W CRI90 | 25957E - | Power supply |  |
| 25951- | Suspension Kit | 25958E - | Electrified lineal joint |  |
| 25952- | Joint | 25959E - | Electrified "L" joint |  |
| 25953- | "L" connector not electrified | 25960E - | Electrified flexible joint |  |
| 25955- | End cap with hole | 25961- | Electrical contact cutting tool |  |

25962E-

Bluetooth (Casambi) adapter



25966-

Joint indirect lighting



25965-

Suspension Kit ind. lighting



25980E - 1
25980E - 1D

Track adaptor for LED strip 48V

Track adaptor for LED strip 48V DALI



Converters

| | | | | | L | W | H | |
|---------|----------------------------------|------|-----|------|--------|-------|--------|--|
| 25990- | Converter 110 -240V | 75W | 48V | IP00 | 99mm | 97mm | 30mm | |
| 25991- | Converter 110 -240V | 150W | 48V | IP00 | 159mm | 97mm | 30mm | |
| 25992- | Converter 220 -240V | 100W | 48V | IP20 | 350mm | 30mm | 18mm | |
| 25993- | Converter 220 -240V | 250W | 48V | IP20 | 400mm | 40mm | 22mm | |
| 25994- | Converter 110 -277V | 240W | 48V | IP67 | 244mm | 71mm | 38mm | |
| 25995- | Converter 110 -277V | 320W | 48V | IP67 | 252mm | 90mm | 44mm | |
| 25999- | Optocoupler for Dali * | | | | | | | |
| 25962E- | Bluetooth (Casambi-DALI) adapter | | | | | | | |
| 25981- | Converter 230 V | 100W | 48V | IP20 | 300 mm | 16 mm | 19mm | |
| 25982- | Converter 230 V | 250W | 48V | IP20 | 270 mm | 22mm | 43,5mm | |

* Required for Dali signal on track systems.



A) External power supply option

Recessed

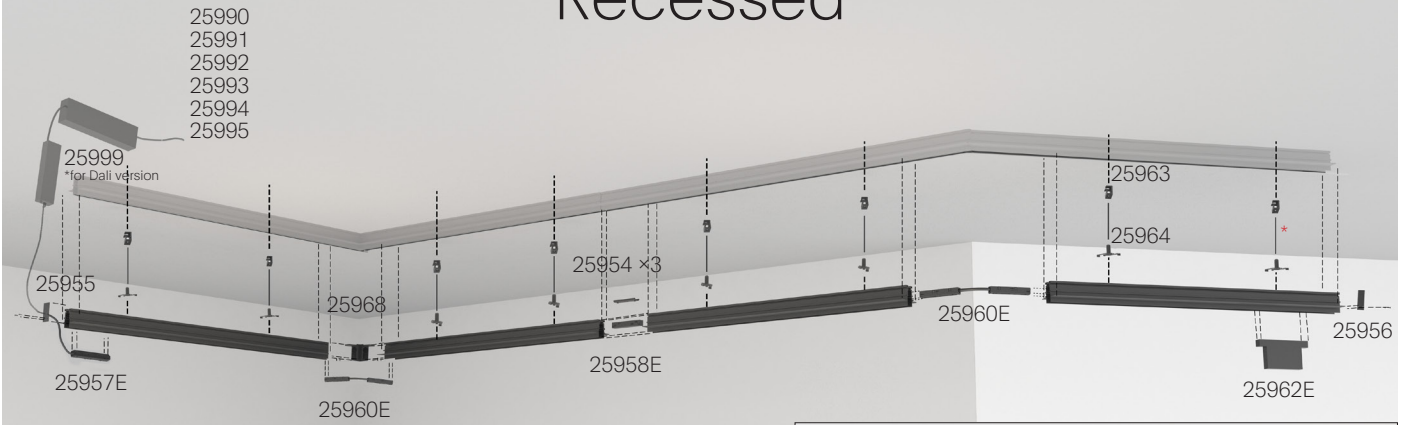

* M6 threaded rod not included

B) Internal power supply option

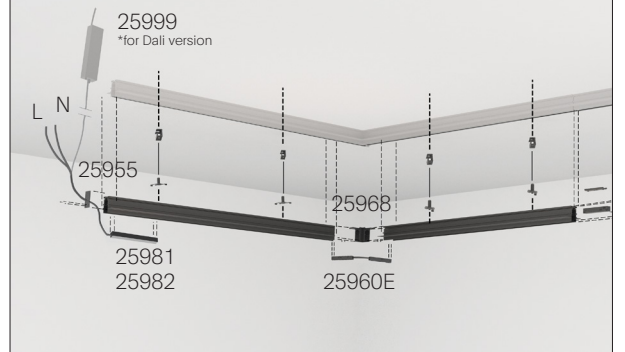

A and B are excluding

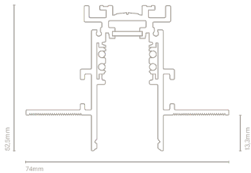

Trimless embeded track







- 25911E-1
- 25912E-1
- 25913E-1

| | | | |
|-------------------------|-----|--------|-------|
| Embedded magnetic track | 15A | 100 cm | Black |
| Embedded magnetic track | 15A | 200 cm | Black |
| Embedded magnetic track | 15A | 300 cm | Black |

Accessories

| | | |
|----------|--------------------------|-------------------------------------------------------------------------------------|
| 25954- | Joint |  |
| 25955- | End cap with hole |  |
| 25956- | End cap without hole |  |
| 25957E - | Power supply |  |
| 25958E - | Electrified lineal joint |  |

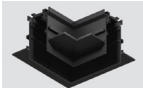
| | | |
|---------|------------------------------------|---------------------------------------------------------------------------------------|
| 25960E- | Electrified flexible joint |  |
| 25962E- | Bluetooth (Casambi) adapter |  |
| 25963- | Ceiling bracket for suspensions |  |
| 25964- | Fast fixing clamp |  |
| 25968- | Horizontal mechanical corner joint |  |

Converters

| | | | | | L | W | H |
|---------|----------------------------------|------|-----|------|--------|------|--------|
| 25990- | Converter 110 -240V | 75W | 48V | IP00 | 99mm | 97mm | 30mm |
| 25991- | Converter 110 -240V | 150W | 48V | IP00 | 159mm | 97mm | 30mm |
| 25992- | Converter 220 -240V | 100W | 48V | IP20 | 350mm | 30mm | 18mm |
| 25993- | Converter 220 -240V | 250W | 48V | IP20 | 400mm | 40mm | 22mm |
| 25994- | Converter 110 -277V | 240W | 48V | IP67 | 244mm | 71mm | 38mm |
| 25995- | Converter 110 -277V | 320W | 48V | IP67 | 252mm | 90mm | 44mm |
| 25999- | Optocoupler for Dali * | | | | | | |
| 25962E- | Bluetooth (Casambi-DALI) adapter | | | | | | |
| 25981- | Converter 230 V | 100W | 48V | IP20 | 300 mm | 16mm | 19mm |
| 25982- | Converter 230 V | 250W | 48V | IP20 | 270 mm | 22mm | 43,5mm |

* Required for Dali signal on track systems.



Egea Arquitectos Office, Tenerife 2021



48V_Track Luminaires

ES

El sistema 48V_Track ofrece una enorme versatilidad. Te permite diseñar líneas, en ángulo recto y cambios de plano en las esquinas a 90°. Con este sistema, puedes instalar sistemas módulos de luz, luminarias suspendidas o los proyectores, combinando la iluminación de acento con iluminación general cuando sea necesario. Su sistema de instalación manual y sin herramientas es muy funcional y simple.

FR

Le système 48V_Track offre une énorme polyvalence. Il vous permet de dessiner des lignes, des angles droits et des changements de plan à des angles de 90°. Avec ce système, vous pouvez installer des systèmes de modules d'éclairage, des luminaires suspendus ou des spots, en combinant l'éclairage d'accentuation avec l'éclairage général lorsque cela est nécessaire. Son fonctionnement manuel et sans outil. Le système d'installation est très fonctionnel et simple.

IT

Il sistema 48V_Track offre un'enorme versatilità. Permette di disegnare linee, angoli retti e cambi di piano agli angoli di 90°. Con questo sistema, è possibile installare sistemi di moduli luminosi, apparecchi a sospensione o faretti, combinando l'illuminazione d'accento con quella generale quando necessario. Il suo manuale e senza attrezzi. Il sistema di installazione è molto funzionale e semplice.

| | |
|-------------------|-------------------|
| Index Protection: | IP20 |
| Voltage: | 48V |
| Driver: | Included |
| CRI: | 90 |
| Lifetime: | 50.000h |
| Temperature: | 2700K/3000K/4000K |
| Technology: | LED |
| Guarantee: | 5 years |
| Class III | |



The 48V_Track system offers a huge versatility. It allows you to draw lines, right angle turns and plane changes in corners at 90°. With this system, you may install diffuse light modules, suspended lighting fixtures or spotlights, combine accent lighting with longitudinal general lighting where required. Its manual and tool-less installation system is highly-functional and simple.

25221E - BCN 30 (250mm)
 25222E - BCN 30 (350mm)
 25223E - BCN 30 (450mm)



25221E-

| COLOUR | CRI/TEMP. | ANGLE | LED | DIMMING |
|------------|-----------|-------|------------|--------------|
| 0 White | H 927 | 1 15° | 0 600lm/6W | - No dimming |
| 1 Black | E 930 | 2 25° | | D DALI |
| A Cooper | | | | |
| D Gold | | | | |
| G Graphite | | | | |

25211E - Suspended ball

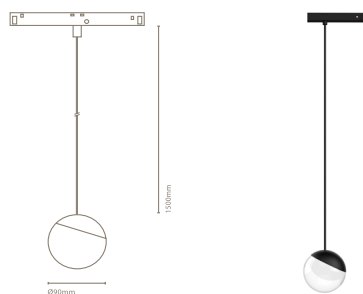

25211E-

| COLOUR | CRI/TEMP. | ANGLE | LED | DIMMING |
|---------|-----------|--------|------------|--------------|
| 1 Black | H 927 | 9 120° | 0 320lm/4W | - No dimming |
| | E 930 | | | D DALI |

25212E - Surfaced ball



25212E-

| COLOUR | CRI/TEMP. | ANGLE | LED | DIMMING |
|---------|-----------|--------|------------|--------------|
| 1 Black | H 927 | 9 120° | 0 320lm/4W | - No dimming |
| | E 930 | | | D DALI |

25112E - 48V Opal lineal (300mm)
 25113E - 48V Opal lineal (900mm)

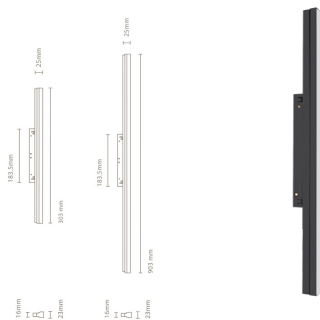

25112E-

| COLOUR | CRI/TEMP. | ANGLE | LED | DIMMING |
|---------|-----------|--------|-------------|--------------|
| 1 Black | H 927 | 9 120° | 0 630lm/10W | - No dimming |
| | E 930 | | | D DALI |
| | F 940 | | | |

25113E-

| COLOUR | CRI/TEMP. | ANGLE | LED | DIMMING |
|---------|-----------|--------|--------------|--------------|
| 1 Black | H 927 | 9 120° | 3 2018lm/30W | - No dimming |
| | E 930 | | | D DALI |
| | F 940 | | | |

25121E - Dot lineal

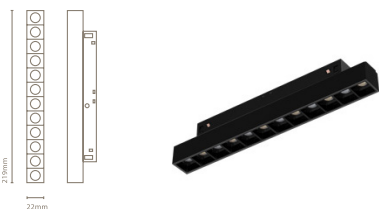

25121E-

| COLOUR | CRI/TEMP. | ANGLE | LED | DIMMING |
|---------|-----------|-------|-------------|--------------|
| 1 Black | H 927 | 2 24° | 0 904lm/15W | - No dimming |
| | E 930 | 3 36° | | D DALI |
| | F 940 | | | |

25031E - Eye

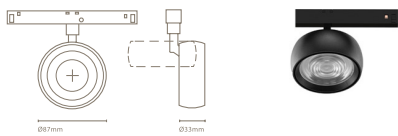

25031E-

| | COLOUR | CRI/TEMP. | ANGLE | LED | DIMMING |
|---|--------|-----------|-------|----------------|--------------|
| 0 | White | H 927 | 1 15° | 2 1500lm/12,5W | - No dimming |
| 1 | Black | E 930 | 3 36° | | D DALI |
| | | F 940 | | | |

25022E - Zoom spotlight 15W

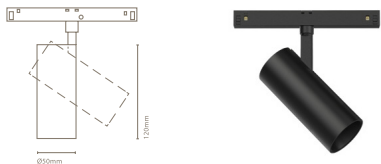

25022E-

| | COLOUR | CRI/TEMP. | ANGLE | LED | DIMMING |
|---|--------|-----------|-------|--------------|--------------|
| 0 | White | H 927 | 1 15° | 0 1025lm/15W | - No dimming |
| 1 | Black | E 930 | 2 24° | | D DALI |
| | | F 940 | 3 36° | | |

25011E - Zoom spotlight 7.7 W

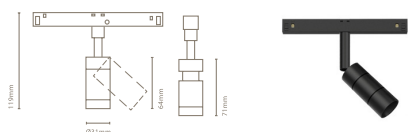

25011E-

| | COLOUR | CRI/TEMP. | ANGLE | LED | DIMMING |
|---|--------|-----------|----------|--------------|--------------|
| 0 | White | H 927 | Z 10-40° | 0 550lm/7,7W | - No dimming |
| 1 | Black | E 930 | | | D DALI |
| | | F 940 | | | |

25231E - 48V Ceiling Lamp



25231E-

| | COLOUR | CRI/TEMP. | ANGLE | LED | DIMMING |
|---|--------|-----------|--------|----------------|---------|
| 1 | Black | H 927 | 9 110° | 2 1825lm / 30W | On-Off |
| | | E 930 | | | D Dali |
| | | F 940 | | | |

25131E - H. Opal lineal direct 1500mm

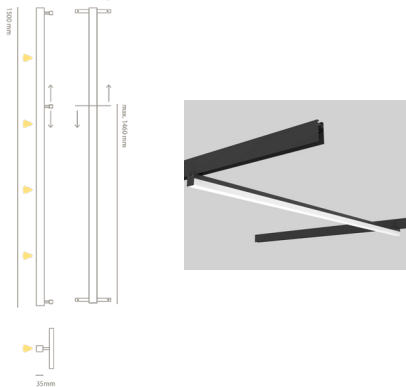

25131E-

| | COLOUR | CRI/TEMP. | ANGLE | LED | DIMMING |
|---|--------|-----------|--------|-----------------|---------|
| 0 | White | H 927 | 9 120° | 1 1300 lm / 20W | On-Off |
| 1 | Black | E 930 | | | D Dali |
| | | F 940 | | | |

25135E - H. Opal lineal indirect 1500mm

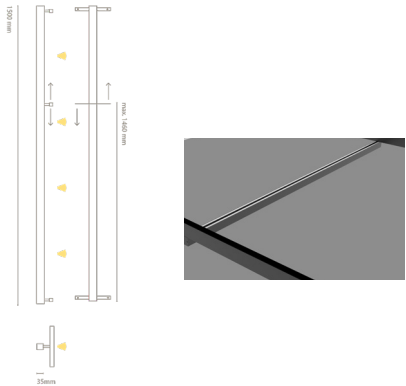

25135E-

| | COLOUR | CRI/TEMP. | ANGLE | LED | DIMMING |
|---|--------|-----------|--------|-----------------|---------|
| 0 | White | H 927 | 9 120° | 1 1300 lm / 20W | On-Off |
| 1 | Black | E 930 | | | D Dali |
| | | F 940 | | | |

